

ACS

Automatisme Confection Services

Pièces de rechange



- Ameublement
- Automobile
- Tissus lourds
- Cuirs

Web: www.acs.tn

LEGEND

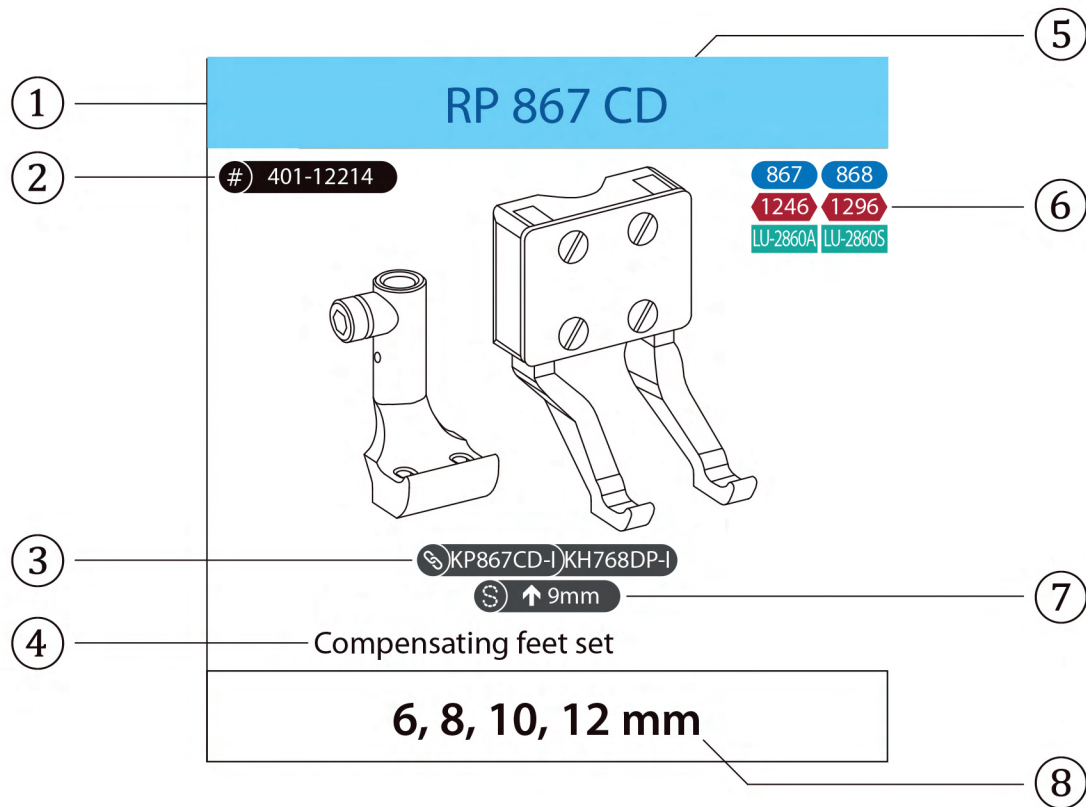

① QR code

Scanning the QR Code for more product information and order it at once

② # Genuine part number

③ Related parts

④ Product description

⑤ Part number

⑥ Applicable machine models

 Durkopp Adler machine models

 Pfaff machine models

 Juki machine models

⑦  Maximum stitch length

⑧ Optional specifications

NEW PRODUCTS

RP 867 C

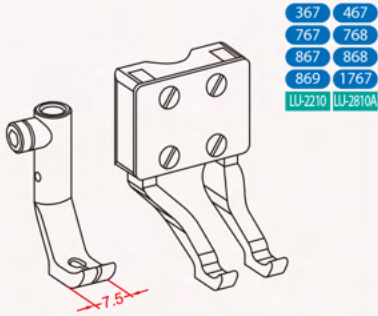

367	467
767	768
867	868
869	1767
LU-2210	LU-2810A

Single needle compensating feet set

GL 367 M

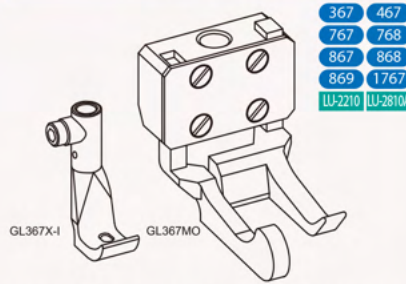

367	467
767	768
867	868
869	1767
LU-2210	LU-2810A

Compensating left guide feet (for extreme heavy)

3, 4, 5, 6, 8, 9 mm

GR 367 M

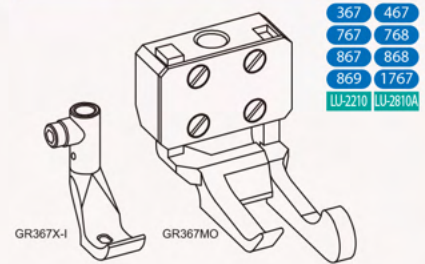

367	467
767	768
867	868
869	1767
LU-2210	LU-2810A

Compensating right guide feet (for extreme heavy)

3, 4, 5, 6, 8, 9 mm

RP 867 CD

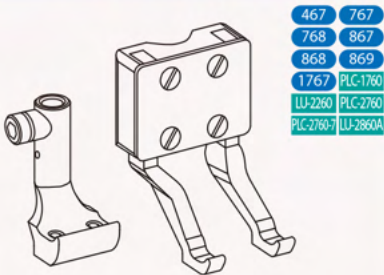

467	767
768	867
868	869
1767	PLC-1760
LU-2260	PLC-2760
PLC-2760-7	LU-2860A

Double needle compensating feet set

6, 8, 10, 12 mm

RP 867 COD

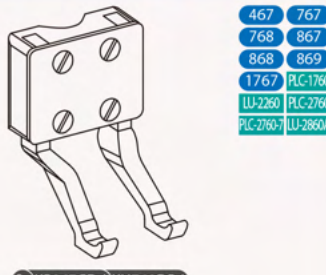

467	767
768	867
868	869
1767	PLC-1760
LU-2260	PLC-2760
PLC-2760-7	LU-2860A

Double needle compensating outer foot
Ⓢ KP867CD-I KH768DP-I

6, 8, 10, 12 mm

RP 867 CD - I

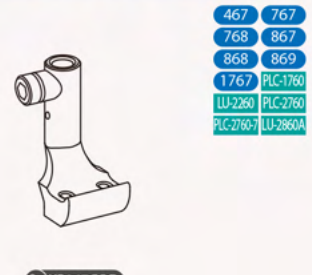

467	767
768	867
868	869
1767	PLC-1760
LU-2260	PLC-2760
PLC-2760-7	LU-2860A

Double needle inner foot
Ⓢ KP867COD

6, 8, 10, 12 mm

RH 768 DP

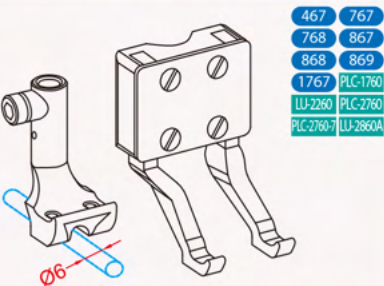

467	767
768	867
868	869
1767	PLC-1760
LU-2260	PLC-2760
PLC-2760-7	LU-2860A

Double needle compensating feet for piping

8, 10, 12 mm

RH 768 DP - I

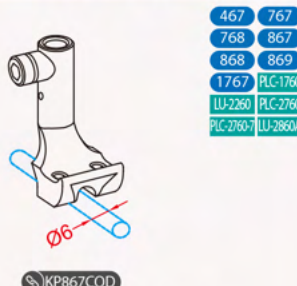

467	767
768	867
868	869
1767	PLC-1760
LU-2260	PLC-2760
PLC-2760-7	LU-2860A

Double needle inner piping foot
Ⓢ KP867COD

8, 10, 12 mm

RP 768 YC

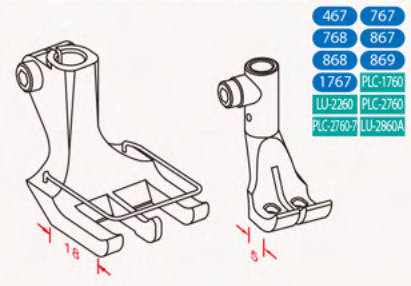

467	767
768	867
868	869
1767	PLC-1760
LU-2260	PLC-2760
PLC-2760-7	LU-2860A

Fixed guiding feet with short toes

6, 8, 10, 12 mm

RP 768 YAO

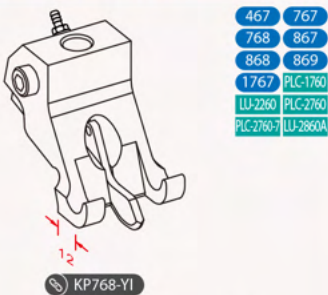

467	767
768	867
868	869
1767	PLC-1760
LU-2260	PLC-2760
PLC-2760-7	LU-2860A

Pneumatic center guiding foot with extremely short toes
Ⓢ KP768-YI

6, 8, 10, 12, 14, 16 mm

RP 768 - YI

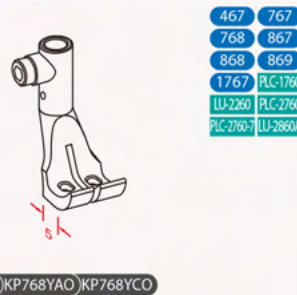

467	767
768	867
868	869
1767	PLC-1760
LU-2260	PLC-2760
PLC-2760-7	LU-2860A

Short toes feeding foot
Ⓢ KP768YAO KP768YCO

6, 8, 10, 12, 14, 16 mm

RP 768 YCO

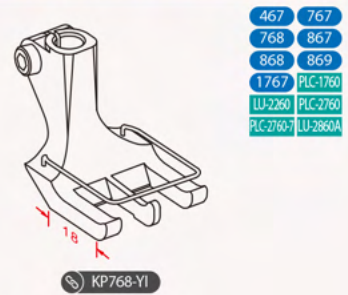

467	767
768	867
868	869
1767	PLC-1760
LU-2260	PLC-2760
PLC-2760-7	LU-2860A

Fixed guiding foot with short toes
Ⓢ KP768-YI

6, 8, 10, 12 mm

NEW PRODUCTS

RP 367 XW

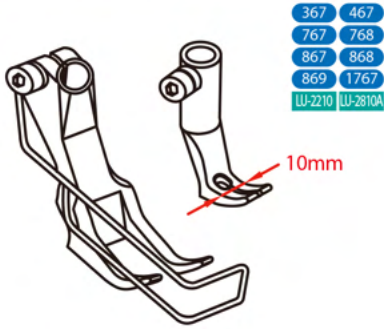

Wider standard feet

367 467
767 768
867 868
869 1767
LU-2210 LU-2810A

RP 867 - N 081

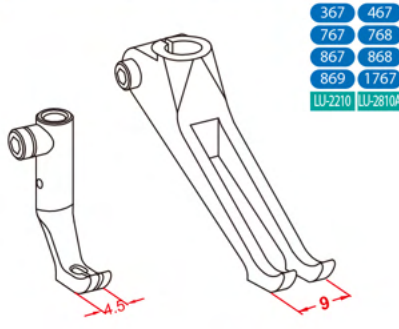

Narrow standard feet

367 467
767 768
867 868
869 1767
LU-2210 LU-2810A

RP 867 - N 081WR

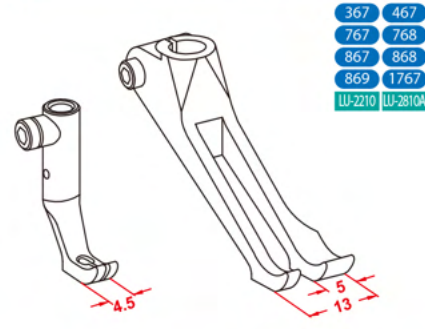

Narrow standard feet with wider right toe

367 467
767 768
867 868
869 1767
LU-2210 LU-2810A

RP 367 ZPW

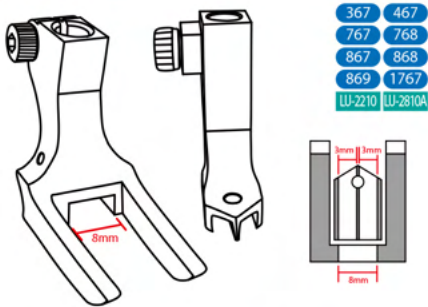

Presser feet for invisible zipper

KHF844

367 467
767 768
867 868
869 1767
LU-2210 LU-2810A

RH 867K - NP/FD

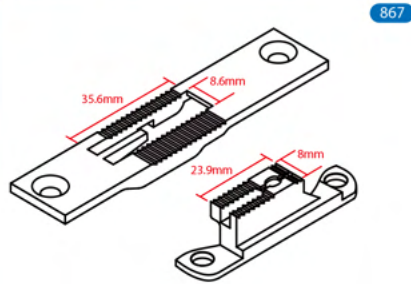

Needle plate & feed dog for thin material

KP367W KP867W

867

RH 867Q - NP/FD

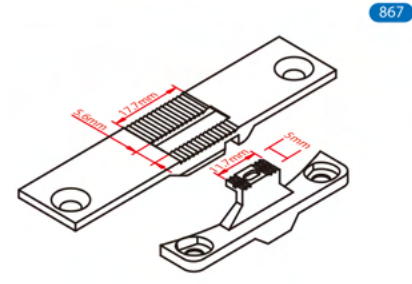

Need plate & feed dog for upturned material, head rest or seam with a large drop-height

KP467Q

867

GL 141

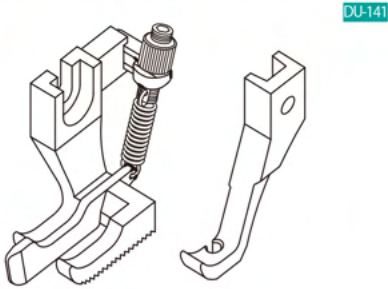

Left guiding feet

1/16", 1/8", 3/16" 1/4"

DU-141

GR 141

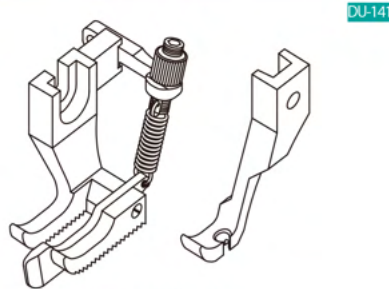

Right guiding feet

1/16", 1/8", 3/16" 1/4"

DU-141

RR 350

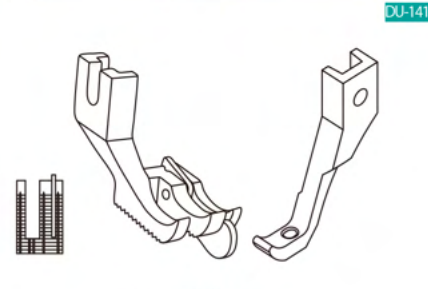

Right guiding feet

1/8", 3/16" 1/4"

DU-141

RP 141 Q

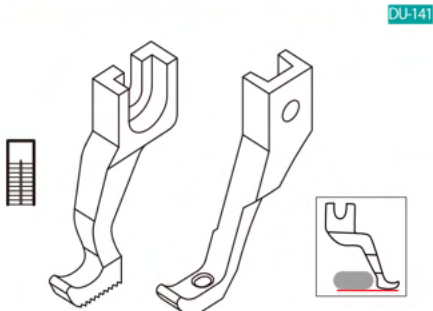

Presser feet for upturned materials

DU-141

RP 1245 VX

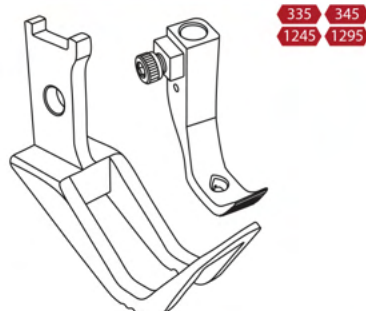

Presser feet for climbing over cross seams

335 345
1245 1295

RP 1525 VX



Presser feet for climbing over cross seams

1445 1525

NEW PRODUCTS

RH 1245 PD

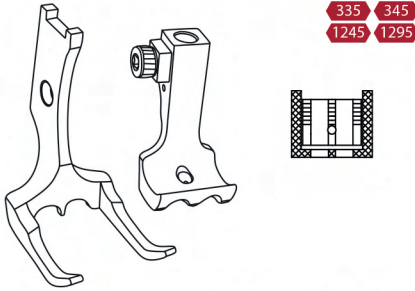

335 345
1245 1295

Double piping groove, needle hole in the middle

3/16" x 2, 1/4" x 2, 3/8" x 2

RH 1510 PD

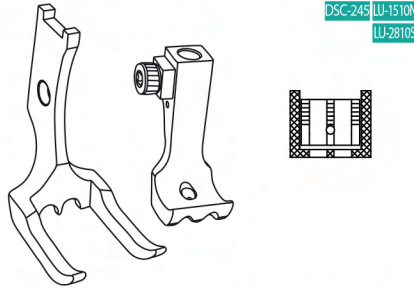

DSC-245 LU-1510N
LU-2810S

Double piping groove, needle hole in the middle

3/16" x 2, 1/4" x 2, 3/8" x 2

RH 1525 PD

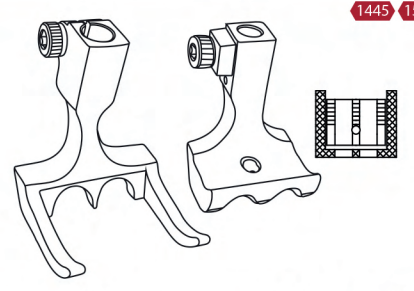

1445 1525

Double piping groove, needle hole in the middle

3/16" x 2, 1/4" x 2, 3/8" x 2

RH 767 AS - SG

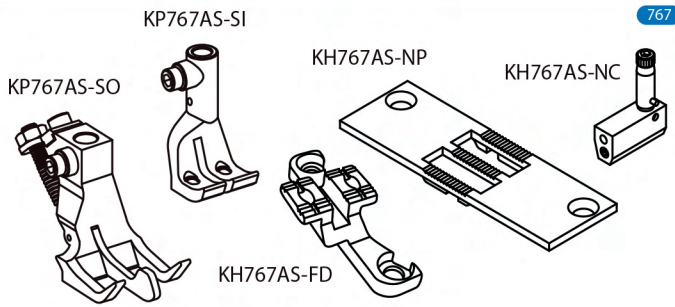

767

Asymmetric guiding gauge set

6, 8, 10, 12 mm

RH 867 AS - SG

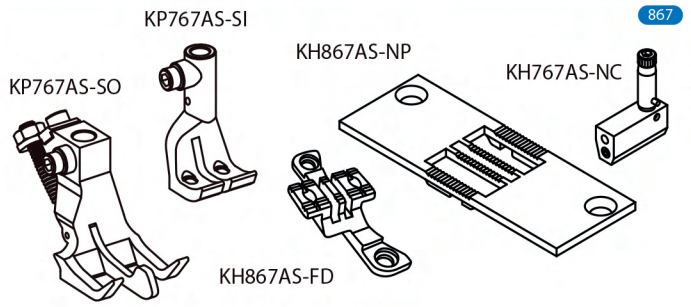

867

Asymmetric guiding gauge set

6, 8, 10, 12 mm

RP 768 CC

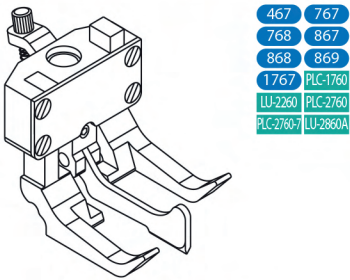

467 767
768 867
868 869
1767 PLC-1760
LU-2260 PLC-2760
PLC-2760-7 LU-2860A

Compensating center guide foot

5, 6, 8, 10, 12, 14, 16 mm

RP 1510 TP

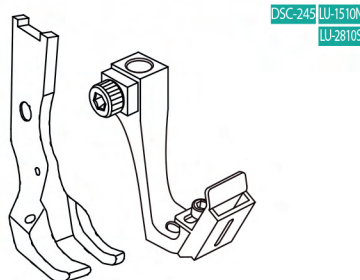

DSC-245 LU-1510N
LU-2810S

Single needle tape attaching feet

Tape Width
1/8", 3/16", 1/4", 5/16", 3/8", 1/2", 5/8", 3/4", 7/8", 1"

RP 1510 TP - I

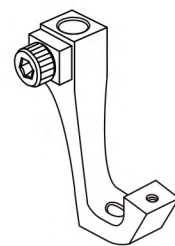

DSC-245 LU-1510N
LU-2810S

Ⓢ KP1510TPO KR-12T

Feeding foot for single needle tape attaching feet

RP 267 TP

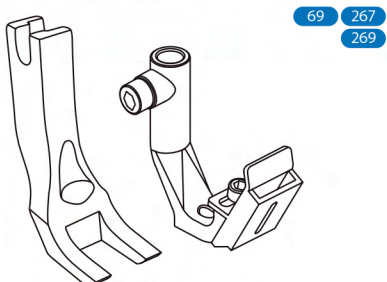

69 267
269

Single needle tape attaching feet

Tape Width
1/8", 3/16", 1/4", 5/16", 3/8", 1/2", 5/8", 3/4", 7/8", 1"

RP 367 TP

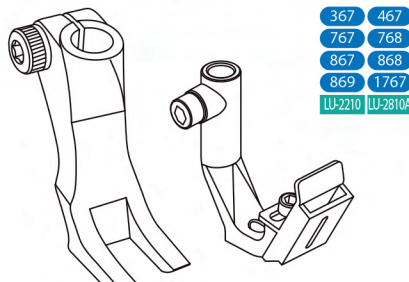

367 467
767 768
867 868
869 1767
LU-2210 LU-2810A

Single needle tape attaching feet

Tape Width
1/8", 3/16", 1/4", 5/16", 3/8", 1/2", 5/8", 3/4", 7/8", 1"

RP 367 TP - I

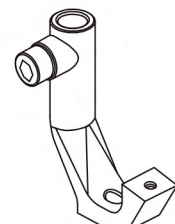

367 467
767 768
867 868
869 1767
LU-2210 LU-2810A

Ⓢ KP267TPO KP367TPO KR-12T

Feeding foot for single needle tape attaching feet

NEW PRODUCTS

RP 269 TP

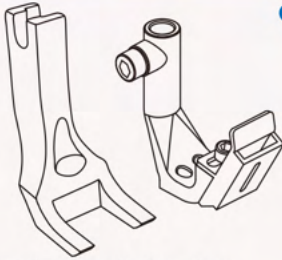

69 267
269

Double needle tape attaching feet

Needle space
4, 5, 6, 8, 10, 12 mm

Tape width
1/8", 3/16", 1/4", 5/16", 3/8", 1/2", 5/8", 3/4", 7/8", 1"

RP 767 TP

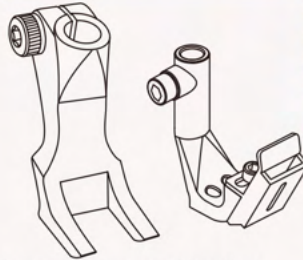

467 767
768 867
868 869
1767 PLC-1760
LU-2260 PLC-2760
PLC-2760-7 LU-2860A

Double needle tape attaching feet

Needle space
4, 5, 6, 8, 10, 12 mm

Tape width
1/8", 3/16", 1/4", 5/16", 3/8", 1/2", 5/8", 3/4", 7/8", 1"

RP 767 TP - I

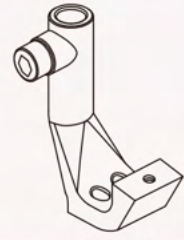

467 767
768 867
868 869
1767 PLC-1760
LU-2260 PLC-2760
PLC-2760-7 LU-2860A

Ⓢ KP269TPO KP767TPO KR-12T

Feeding foot for double needle tape attaching feet

4, 5, 6, 8, 10, 12 mm

RR - 12 T

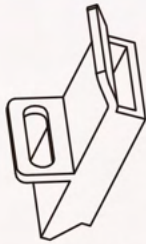

Ⓢ KP367TP-I KP767TP-I KP1510TP-I

Tape tube

Tape Width
1/8", 3/16", 1/4", 5/16", 3/8", 1/2", 5/8", 3/4", 7/8", 1"

RH 291 - NB

291



Needle bar

RH 1296 - NB

346 1246
1296 1526



Ⓢ KH1296-NC

Needle bar

RA 768 - F

768 868
PLC-2760 PLC-2760-7

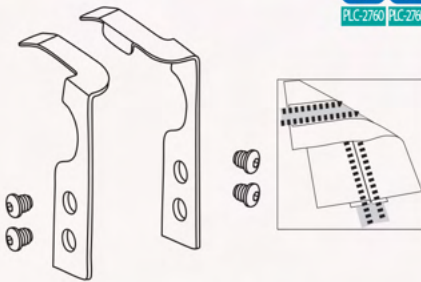

Ⓢ KA768-BG KA768-LBG

Downturn hemmer attachment

RA 768 - FBG

768 868
PLC-2760 PLC-2760-7

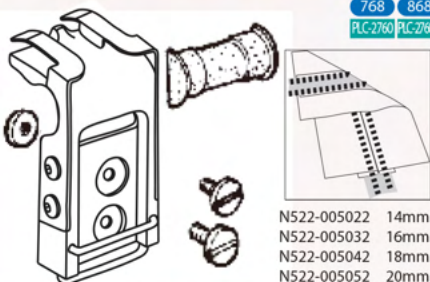

Belt guide with downturn hemmer

N522-005022 14mm
N522-005032 16mm
N522-005042 18mm
N522-005052 20mm

10, 12, 14, 16, 18, 20 mm

RA 768 - LBG

768 868
PLC-2760 PLC-2760-7

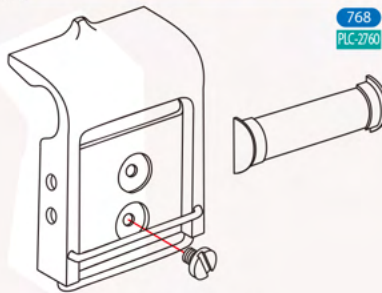

Wider belt guide

22, 24, 26, 28, 30, 32 mm

RA 768 - LBI

768 868
PLC-2760 PLC-2760-7



Ⓢ KA768-LBG

Wider belt insert

22, 24, 26, 28, 30, 32 mm

NEW PRODUCTS

RH 669 - NP/FD

669

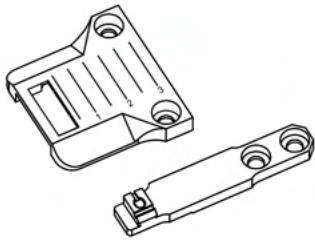

Ⓢ ↑ 9mm

Standard needle plate & feed dog

RH 669 R - NP/FD

669

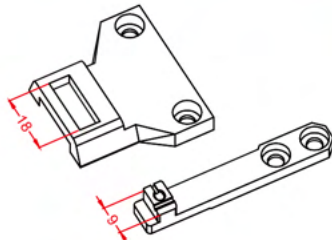

Ⓢ ↑ 9mm

Raised needle plate & feed dog

RH 669 D - NP/FD

669

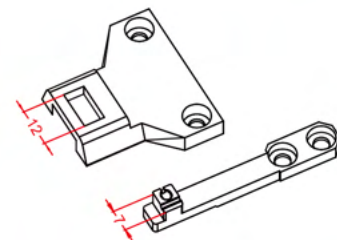

Ⓢ ↑ 5mm

Raised, small needle plate & feed dog

RA - CNS

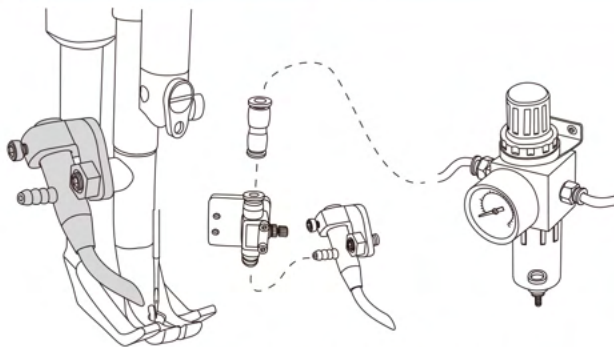

Needle cooler for single needle machine

RA - CND

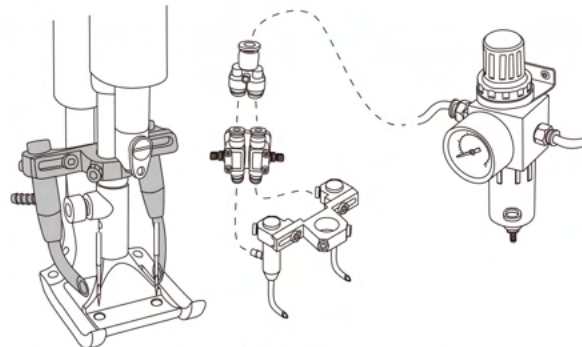

Needle cooler for double needle machine

RH 367 RFG

367 467
767 768
867 868
869 1767
LU-2210 LU-2810A

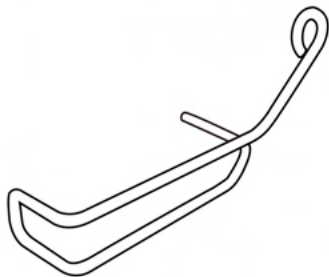

Ⓢ KP367W KP367XW KP367N KP367LN KP367RN
Ⓢ KP367-N081 KP367-L081 KP367-R081 KP367F KP367T

Finger guard for single needle presser feet (Right)

RH 367 RFG 2

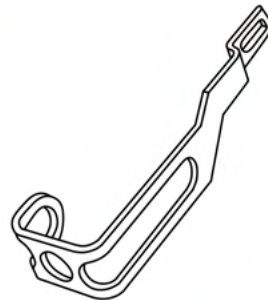

Universal stronger finger guard (Right)

RH 867 FG

867 868

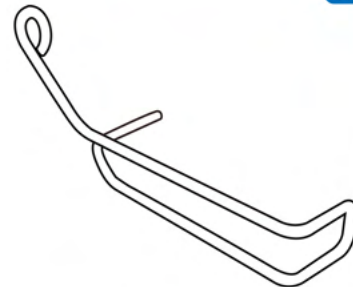

Ⓢ KP867W KP867LN KP867RN

Finger guard for single needle presser feet

RH 1510 FG

335 1245
LU-1510N LU-2810S



Finger guard for single needle presser feet

RH 1560 FG

1246 1296
LU-1560N

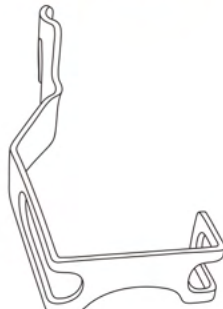

Finger guard for double needle presser feet

0667 - 155100

767 867

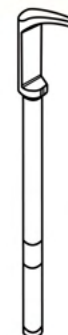

Lifter lever

SUSPENDING GUIDES ET BRACKETS

RG 779 L

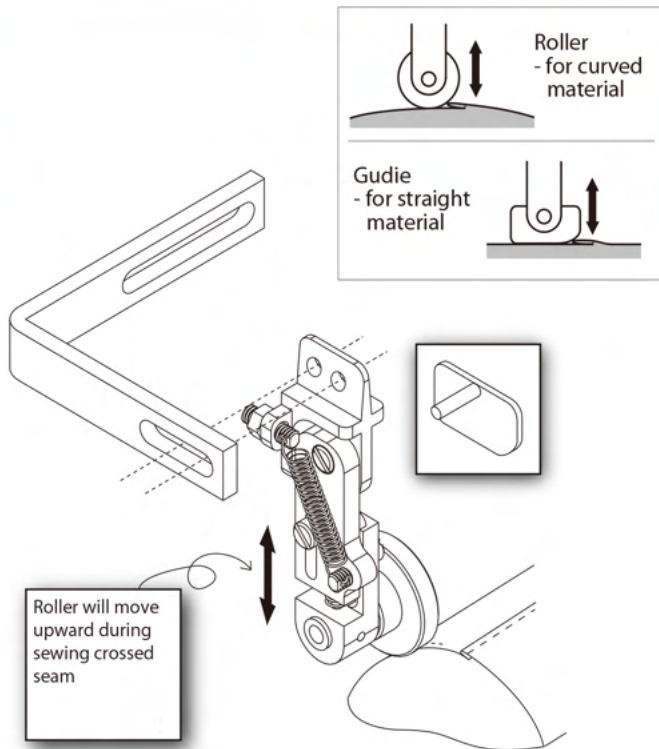

- KB09 KB205 KB267 KB295 KB591
- KB767 KB867 KB967 KB1230 KB2810

Left compensating roller guide

RG 779 R

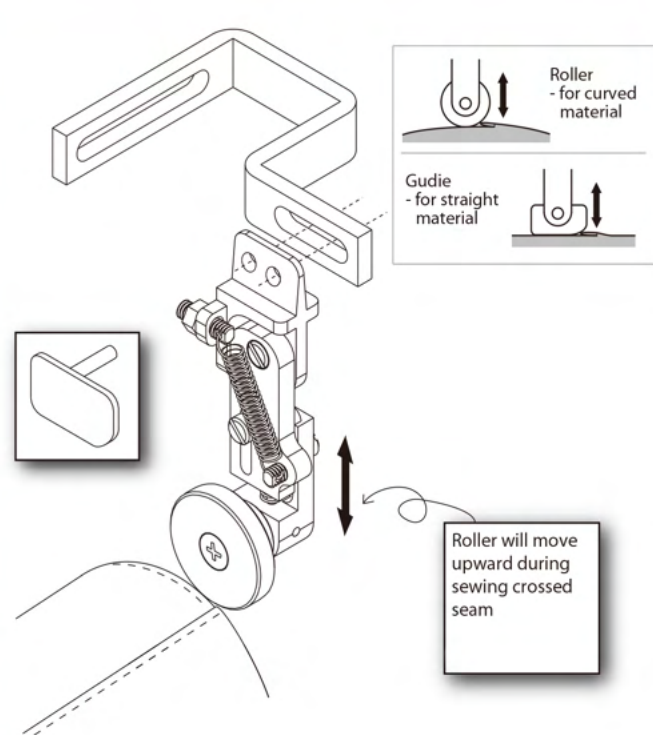

- KB09 KB205 KB267 KB295 KB591
- KB767 KB867 KB967 KB1230 KB2810

Right compensating roller guide

RG 867 P

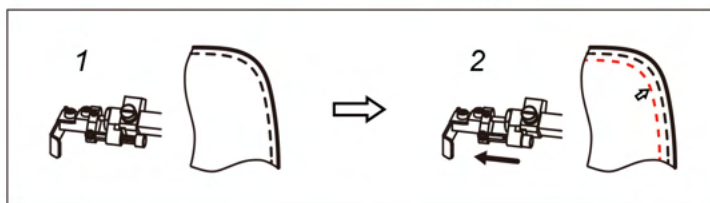
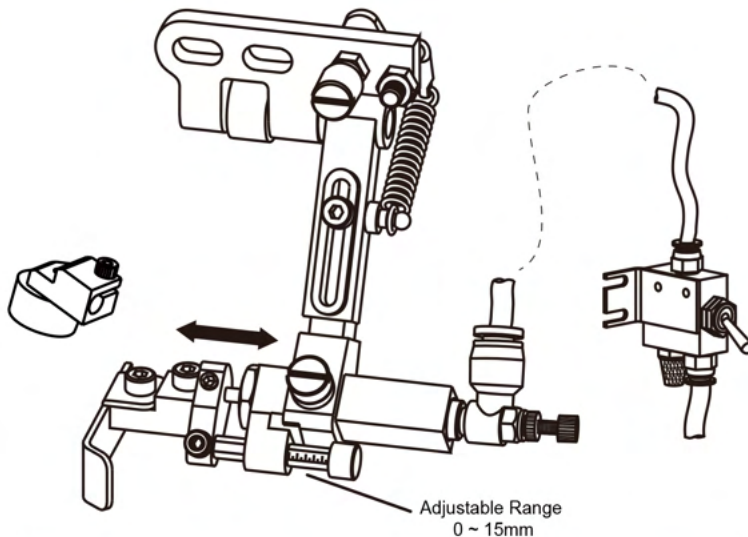

- KG867P-LAK KB09 KB205 KB267 KB295 KB591 KB767 KB867
- KB967 KB1230 KB2810 KG-AB KG-AC KG-AD KG-BZ KG-BZ5
- KG-NR KG-S11 KG-S04

Pneumatic 2 steps adjustable suspending guide

RG 867 P - LAK

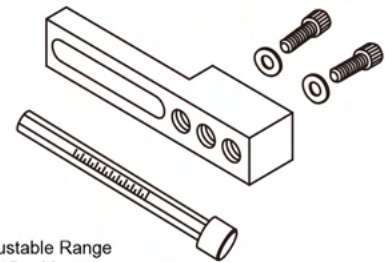

Adjustable Range
15 ~ 30mm

- KG867P

15 - 30mm stitches distance adjustment kit for KG867P
KG867P 15 - 30mm

RG - AD

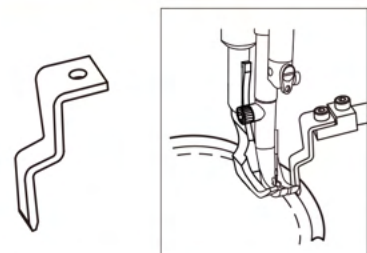

- KG-AA KG141 KG367B KG767A KG767B
- KG767LR KG778 KG867A KG867P KG867S
- KG867Y KG967A KG1245

Guiding knife for curve stitch

SUSPENDING GUIDES ET BRACKETS

RG - BZS

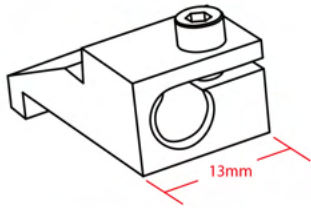

- Ⓢ KG141 Ⓢ KG367B Ⓢ KG767A Ⓢ KG767B Ⓢ KG767LR
- Ⓢ KG778 Ⓢ KG867A Ⓢ KG867P Ⓢ KG867S Ⓢ KG867Y
- Ⓢ KG967A Ⓢ KG1245

Zipper guide

RB 967

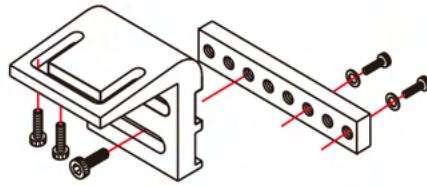

- Ⓢ KG967A

Mounting bracket

RB 2810

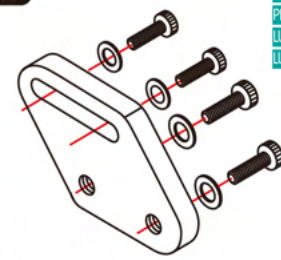

- Ⓢ KG767A Ⓢ KG767B Ⓢ KG767LR Ⓢ KG867A Ⓢ KG867D
- Ⓢ KG867N Ⓢ KG867P Ⓢ KG867S Ⓢ KG867Y Ⓢ KG967A

Mounting bracket

PLC-2710	PLC-2710-7
PLC-2760	PLC-2760-7
LU-2810A	LU-2810B
LU-2860A	LU-2860B

ACS
Advanced Carton Services

ATTACHMENTS FOR BINDING

RHB 669

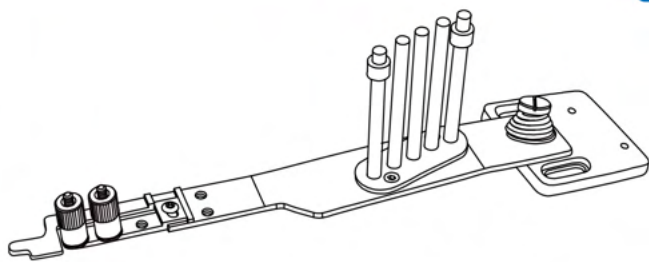

- Ⓢ KP367B Ⓢ KH669-NPB Ⓢ KH669-FDB Ⓢ KHf2 Ⓢ KHf3
- Ⓢ KHf4 Ⓢ KHf4410 Ⓢ KHf867S Ⓢ KHf867T Ⓢ KHf867UT

Moving arm for binding

RHB 767

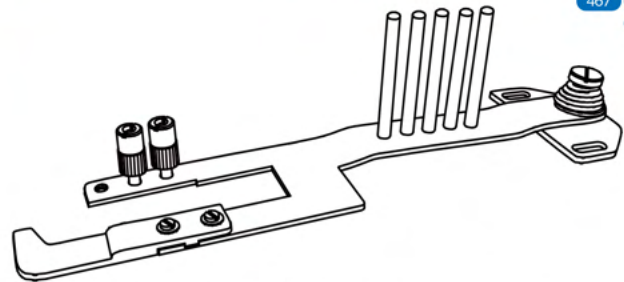

- Ⓢ KH467B Ⓢ KH867-BNP Ⓢ KH867-BFD Ⓢ KHf2 Ⓢ KHf3
- Ⓢ KHf4 Ⓢ KHf4410 Ⓢ KHf867S Ⓢ KHf867T Ⓢ KHf867UT

Moving arm for binding

RHF 91045

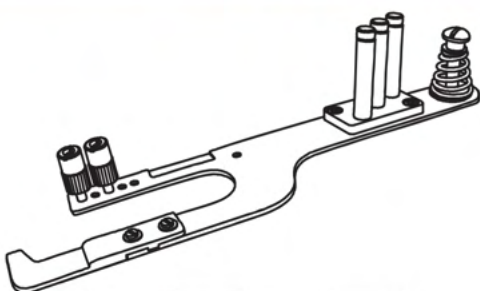

- Ⓢ KH1245-NPB Ⓢ KH1245-FDB Ⓢ KHf2 Ⓢ KHf3
- Ⓢ KHf4 Ⓢ KHf4410 Ⓢ KHf867S Ⓢ KHf867T Ⓢ KHf867UT

Moving arm for binding

RHB 01

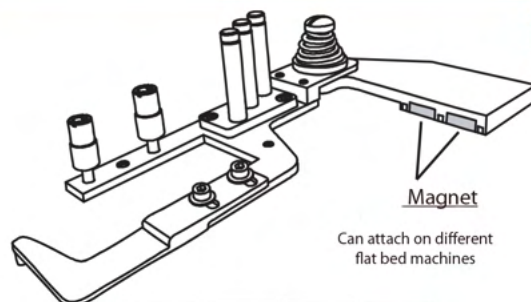

- Ⓢ KH2810B-NP Ⓢ KH467B-FD Ⓢ KHf2 Ⓢ KHf3
- Ⓢ KHf4 Ⓢ KHf4410 Ⓢ KHf867S Ⓢ KHf867T Ⓢ KHf867UT

Moving arm for universal flat bed machine models

Magnet

Can attach on different flat bed machines

ATTACHMENTS FOR BINDING

RHF 867 S

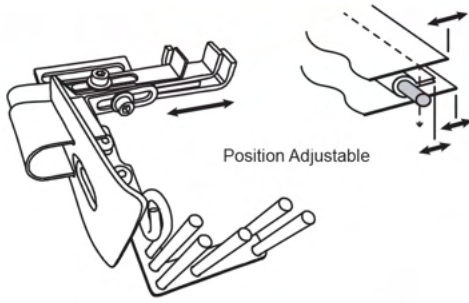

Position Adjustable

Ⓢ KHB01 KHB669 KHB767 KHF91045

Cord welting attachment

RHF 867 T

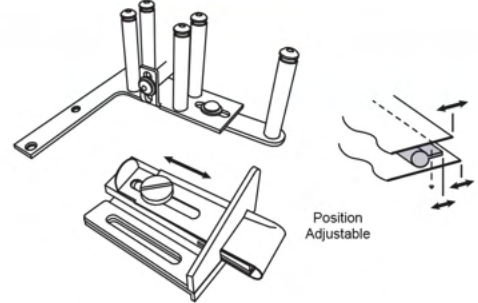

Position Adjustable

Ⓢ KHB01 KHB669 KHB767 KHF91045

Vinyl welting attachment

RHF 867 UT

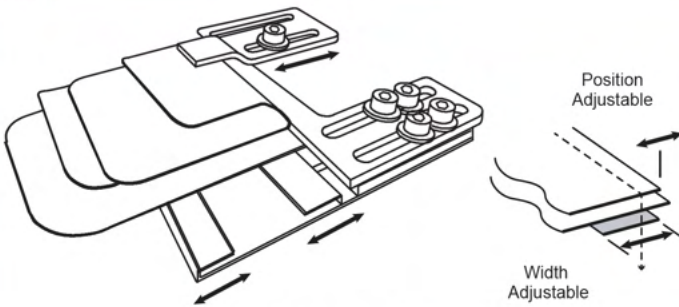

Position Adjustable

Width Adjustable

Ⓢ KHB01 KHB669 KHB767 KHF91045

Under tape attachment

RHF 4410

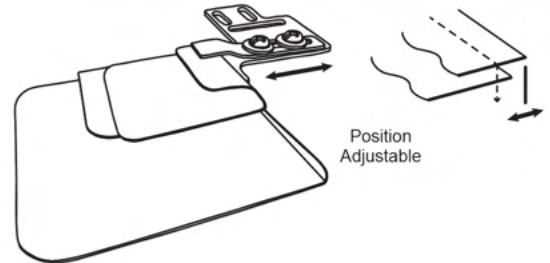

Position Adjustable

Ⓢ KHB01 KHB669 KHB767 KHF91045

RH 205 - FNP/ FDB

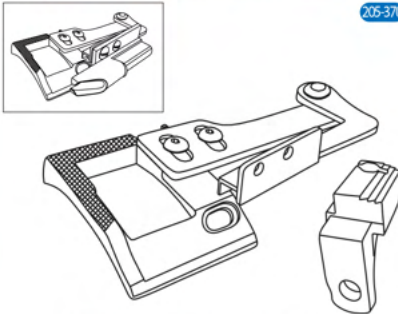

205-370 TSC-441

Ⓢ KP205B KHF2 KHF3 KHF4

Needle plate & feed dog for binding

RHF 2

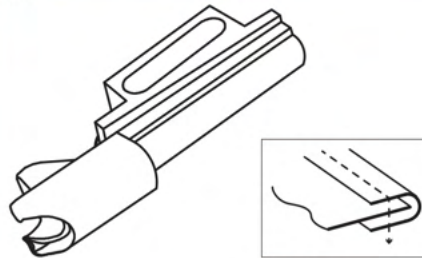

Ⓢ KA69 KHB01 KHB669 KHB767
Ⓢ KHF91040 KHF91045

Raw edge binder

10, 12, 14, 16, 18, 20, 22, 24, 26mm

RHF 2

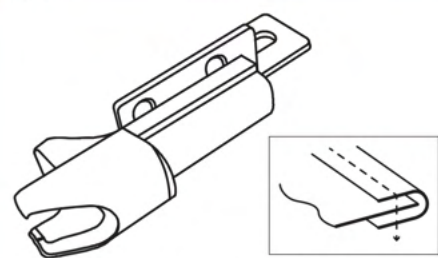

Ⓢ KA69 KHB01 KHB669 KHB767
Ⓢ KHF91040 KHF91045

Raw edge binder

5/8", 3/4", 7/8", 1"

RHF 3

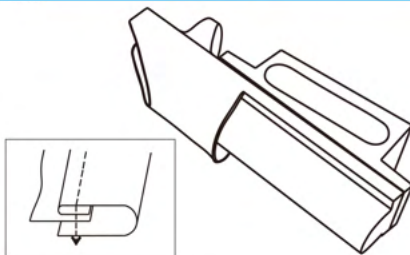

Ⓢ KA69 KHB01 KHB669 KHB767
Ⓢ KHF91040 KHF91045

Single fold binder

18, 20, 22, 24, 26, 28mm

RHF 4

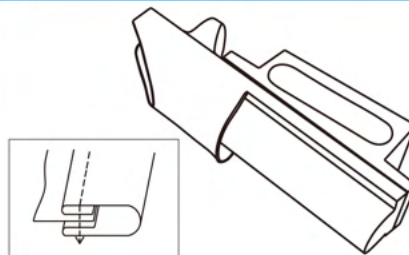

Ⓢ KA69 KHB01 KHB669 KHB767
Ⓢ KHF91040 KHF91045

Double fold binder

18, 20, 22, 24, 26, 28, 30, 32mm

ATTACHMENTS FOR BINDING

RH 467 B

467 767

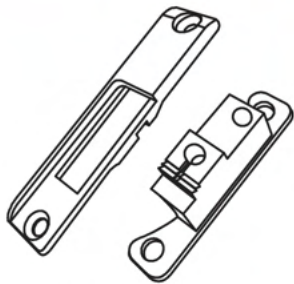

KP367B KHB767

Needle plate & feed dog for binding

RH 669 - NPB/FDB

669

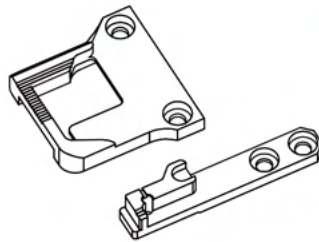

KP367B KHB669

Needle plate & feed dog for binding

RH 867 - BNP/BFD

867

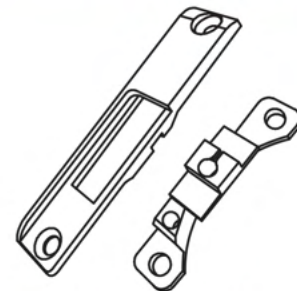

KP367B KHB767

Needle plate & feed dog for binding

RH 1245 - NPB/FDB

1245

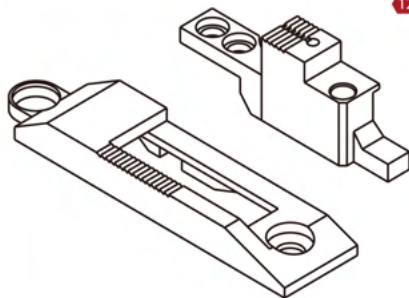

KP335FB KHF91045

Needle plate & feed dog for binding

RH 1525 - NPB/FDB

1525

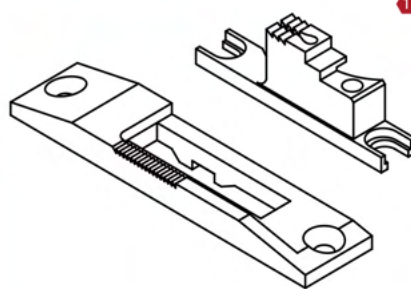

KP1525B KHF91045

Needle plate & feed dog for binding

RH 2810 - NPB+RH467B-FD

LU-2810A LU-2810S

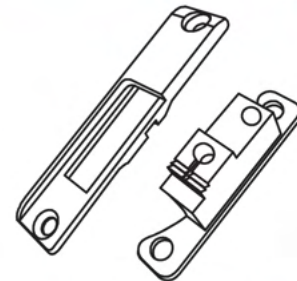

KP367B KHB01

Needle plate & feed dog for binding

RP 335 FB

#) 91-044 227-04 #) 91-042 819-93

335 1245

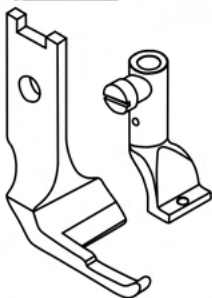

KH1245-NPB KH1245-FDB KHF91040 KHF91045

Presser feet for binding

RP 367 B

367 467

669 767

867 1767

LU-2210 PLC-2710

PLC-2710-7 LU-2810A

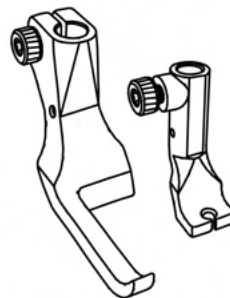

KH467B KH669-NPB KH669-FDB KH867-BNP KH867-BFD

KH2810-NPB KH467B-FD KHB01 KHB669 KHB767

Presser feet for binding

RP 1525 B

1525

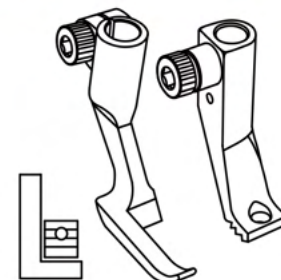

KH1525-NPB KH1525-FDB KHF91045

Presser feet for binding

RP 205 B

205-370 TSC-441



KH205-FNP KH205-NPB KH205-FDB

Presser feet for binding

SEWING FEET

RP 367 W

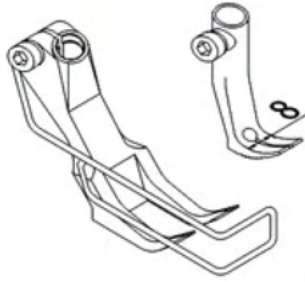

Standard feet

RP 367 XW

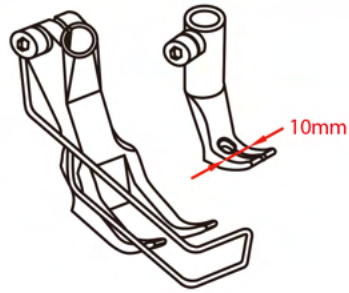

Wider standard feet

RP 367 N

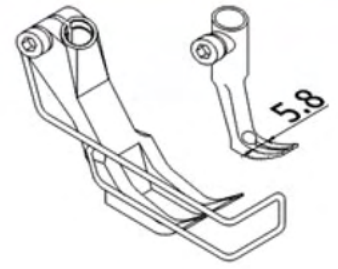

Narrow standard feet

RP 367 LN

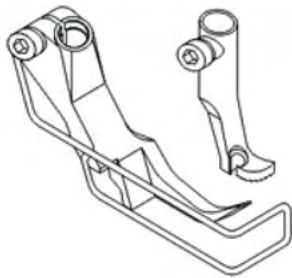

Left cording feet

RP 367 RN

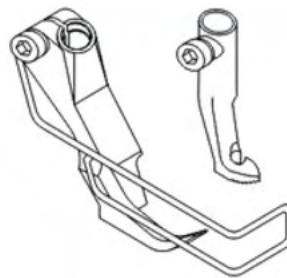

Right cording feet

RP 367 T

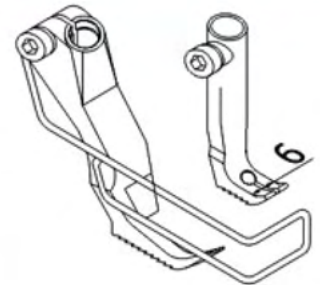

Presser feet for zipping

RP 367 N 081

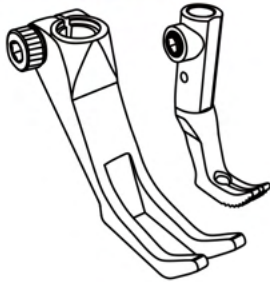

Presser foot width : 10mm
Feeding foot width : 4.5mm
Narrow standard feet

RP 367 - L081

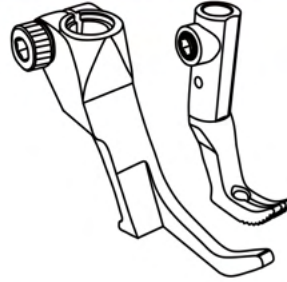

Presser foot width : 7.5mm
Feeding foot width : 4.5mm
Narrow left cording feet

RP 367 - R081



Presser foot width : 7.5mm
Feeding foot width : 4.5mm
Narrow right cording feet

RP 467 Q

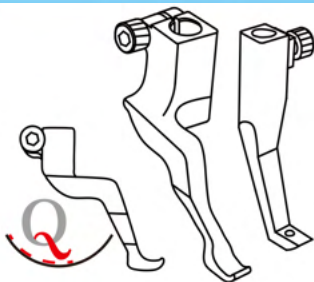

Presser feet for upturned material,
head rest or seam with a large drop-height

RP 367 VX

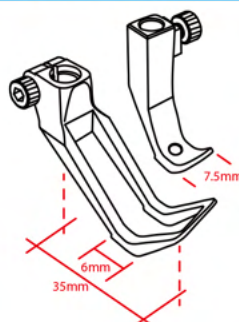

Climbing over cross seams

RP 367 VC

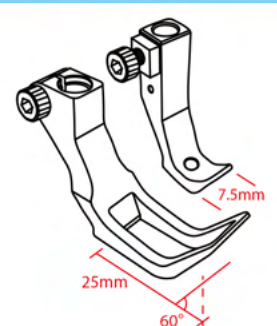

Climbing over thicker materials

SEWING FEET

RP 367 B

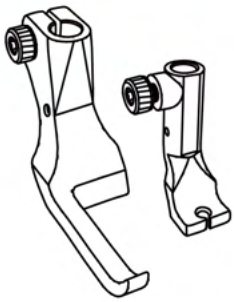

(KH2810-NPB) (KH467B-FD) KHB01

Presser feet for binding

RP 367 F

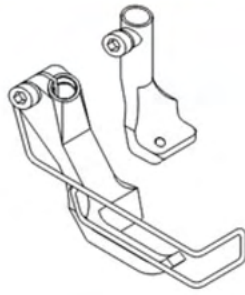

Presser feet for binding

RP 367 TP

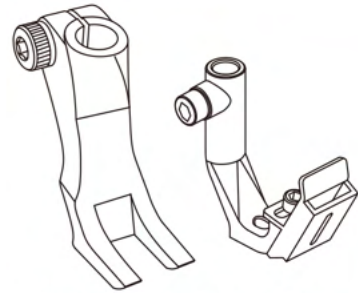

Single needle tape attaching feet

Tape Width

1/8", 3/16", 1/4", 5/16", 3/8", 1/2", 5/8", 3/4", 7/8", 1"

RP 367 ZP

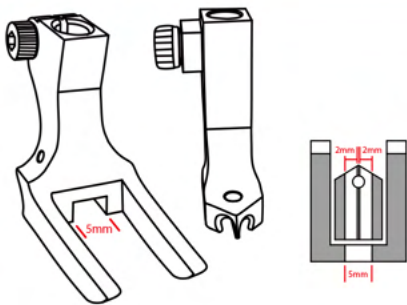

(KHF844)

Presser feet for invisible zipper

RP 367 ZPW

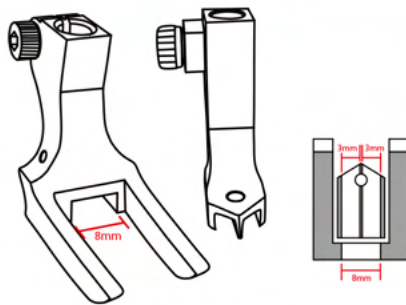

(KHF844)

Presser feet for invisible zipper

RP 367 LV

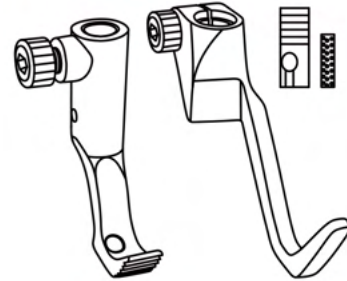

Left cording feet for climbing cross seams

RP 367 RV

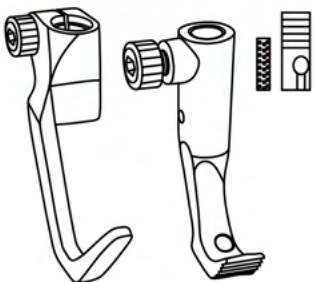

Right cording feet for climbing cross seams

RP 467 LW

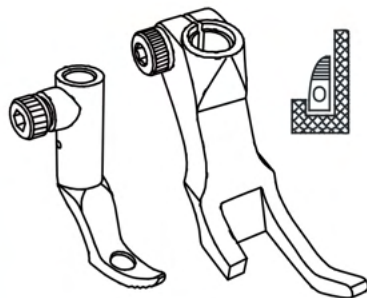

Left cording feet for heavy materials

RP 467 RW

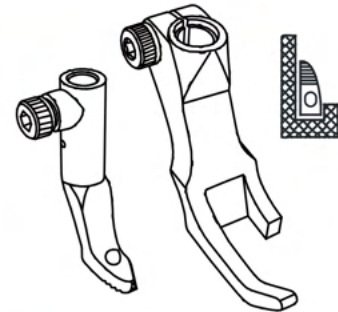

Right cording feet for heavy materials

RP 367 S

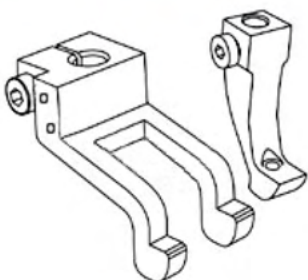

Presser feet for meticulous stitching

RP 10711703

107-11703

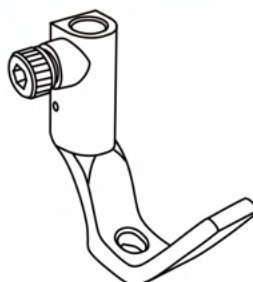

Climbing over thicker materials

SEWING FEET

GL 367

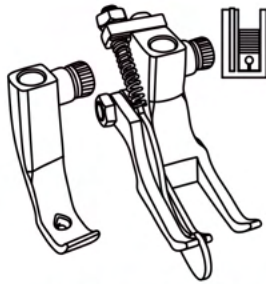

Left compensating guide feet

2, 3, 4, 5, 6, 8, 9 mm

GR 367

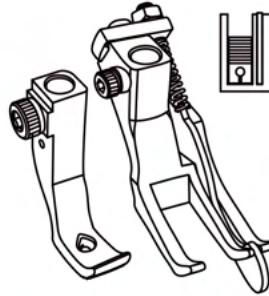

Right compensating guide feet

2, 3, 4, 5, 6, 8, 9 mm

GL 367 X



Stronger left compensating guide & wider feeding foot for HEAVY DUTY

3, 4, 5, 6, 8, 9 mm

GR 367 X

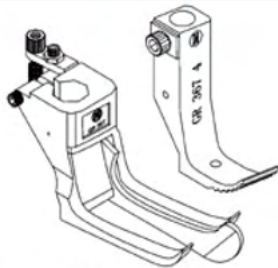

Stronger right compensating guide & wider feeding foot for HEAVY DUTY

3, 4, 5, 6, 8, 9 mm

GL 367 H

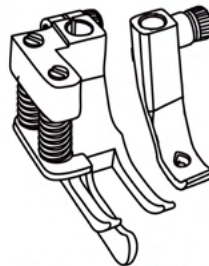

Deeper left compensating guide with balancing spring for EXTREME HEAVY DUTY

4, 5, 6, 7, 8, 9 mm

GR 367 H

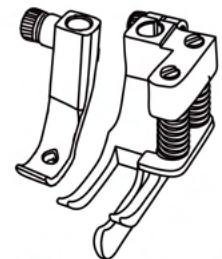

Deeper right compensating guide with balancing spring for EXTREME HEAVY DUTY

4, 5, 6, 7, 8, 9 mm

GL 367 M

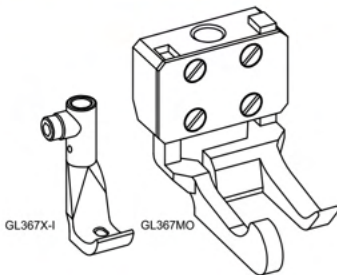

Compensating left guide feet (for extreme heavy)

3, 4, 5, 6, 8, 9 mm

GR 367 M

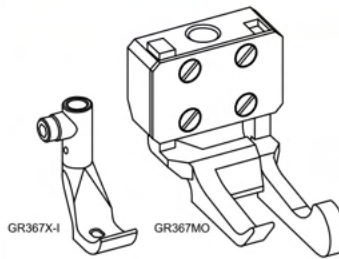

Compensating right guide feet (for extreme heavy)

3, 4, 5, 6, 8, 9 mm

GD 367

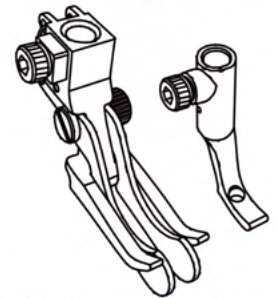

Double compensating guide feet

3/32", 1/8", 3/16", 1/4"

R 367 R

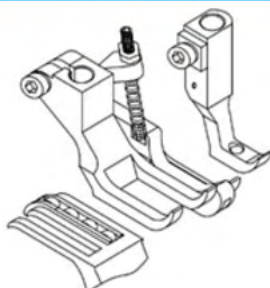

Right roller guide feet

3, 4, 5, 6 mm

RH 767 TG

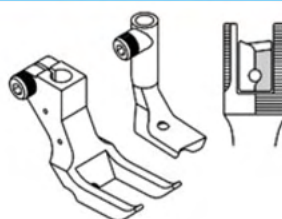

KHB01 KHF867T

Piping feet

4, 5, 6, 8 mm

RH 767 WG

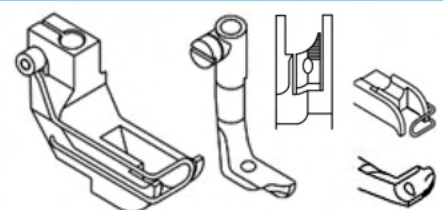

KHB01 KHF867S

Piping feet

5mm (W) x 5mm (H), 5mm (W) x 7mm (H)

SEWING FEET

RH 367 PF

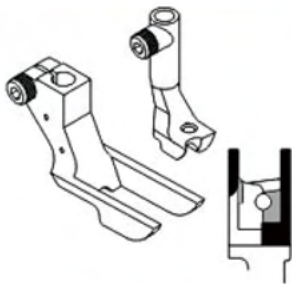

LU-2810A

Cording groove on the left of the needle

3, 4, 5, 6, 8, 9 mm

RH 367 PL

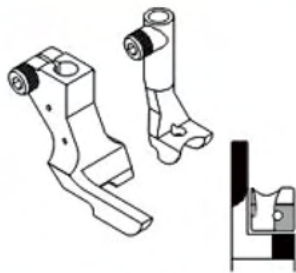

LU-2810A

Cording groove on the left of the needle

3, 4, 5, 6, 8, 9 mm

RH 367 PR

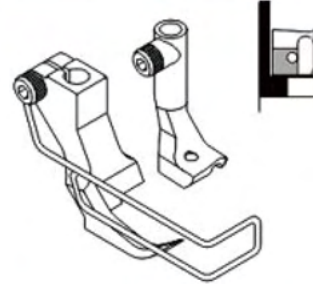

LU-2810A

Cording groove on the right of the needle

3.2, 4.8, 6.4, 8, 9 mm

RH 367 PB

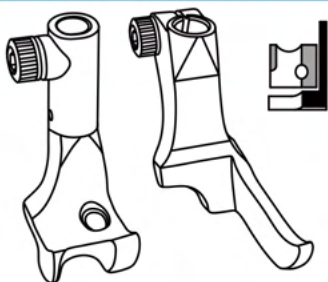

LU-2810A

Piping operation to the left of the needle

4, 5, 6, 8, 9 mm

RH 367 PC

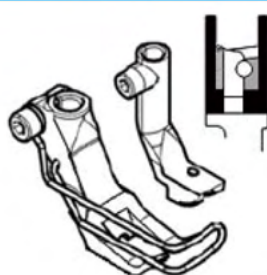

LU-2810A

Piping operation to the left of the needle

4, 5, 6, 8, 9 mm

RH 367 PCS

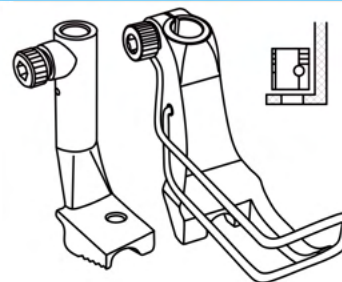

LU-2810A

Piping operation to the left of the needle

4, 5, 6, 8, 9 mm

RH 367 PD

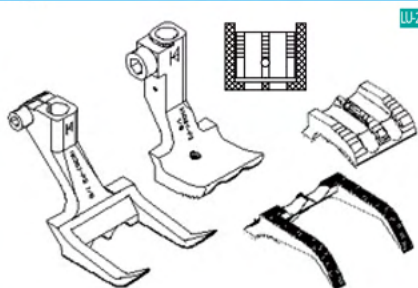

LU-2810A

Double piping groove, needle hole in the middle

3/16" x 2, 1/4" x 2, 3/8" x 2
5mm x 2, 6mm x 2, 8mm x 2

RH 367 PJ

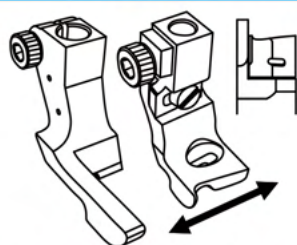

LU-2810A

Cording groove on the left of the needle.
Groove position is adjustable in order to adjust
the space between the needle and the cord.

3, 4, 5, 6, 7, 8, 9 mm

RH 367 TG

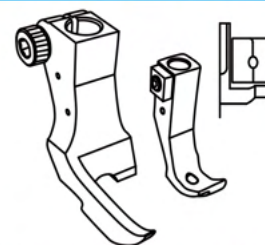

LU-2810A

Cording groove on the left of the needle
its welt groove is integrated one half each
in the presser feet and feeding feet

3, 4, 5, 6 mm

RP 1510 TP

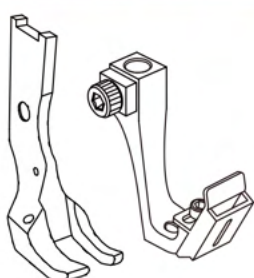

LU-2810S

Single needle tape attaching feet

Tape Width

1/8", 3/16", 1/4", 5/16", 3/8", 1/2", 5/8", 3/4", 7/8", 1"

RP 1510 TP - I

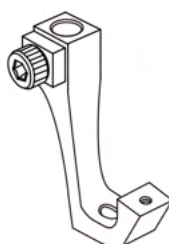

LU-2810S

Feeding foot for single needle tape attaching feet

KP1510TPO KR-12T

RH 1510 PD

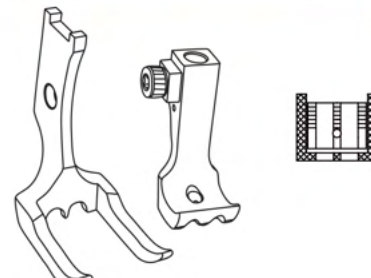

LU-2810S

Double piping groove, needle hole in the middle

3/16" x 2, 1/4" x 2, 3/8" x 2

SEWING FEET

RP 1510 W

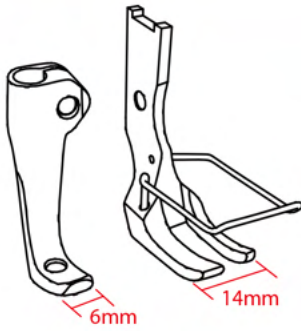

Standard feet

RP 1510 LN



Left cording feet set

RP 1510 RN

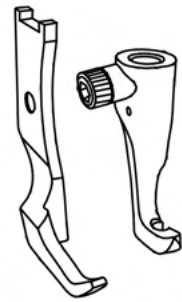

Right cording feet set

RP 1510 F

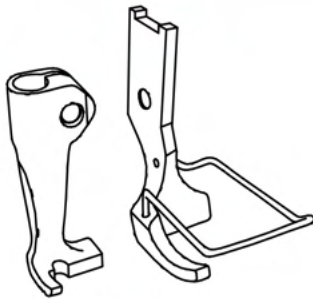

For binding

RP 1510 - N 081

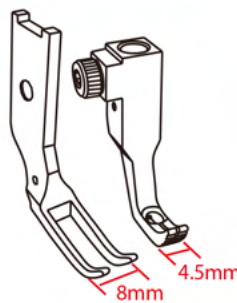

Narrow standard feet

RP 1510 - L081

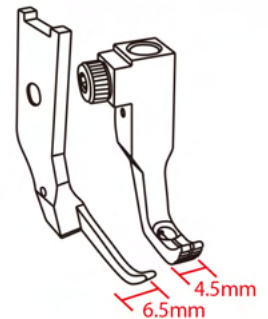

Narrow left cording feet

RP 1510 - R081

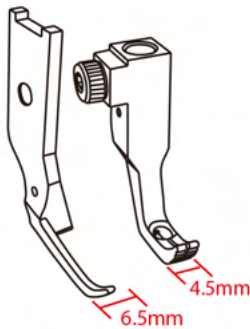

Narrow right cording feet

GL 1510



Left compensating guide feet

3, 4, 5, 6 mm

GR1510

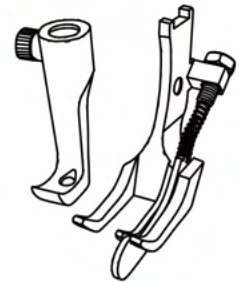

Right compensating guide feet

3, 4, 5, 6 mm

GL 1510 H

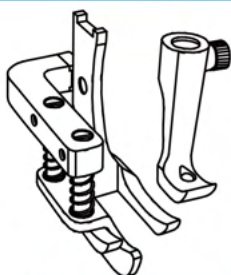

Deeper left compensating guide with balancing spring for EXTREME HEAVY DUTY

5, 6, 8, 9 mm

GR 1510 H

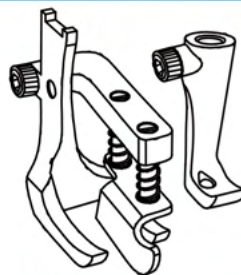

Deeper right compensating guide with balancing spring for EXTREME HEAVY DUTY

5, 6, 8, 9 mm

RP 1510 VX

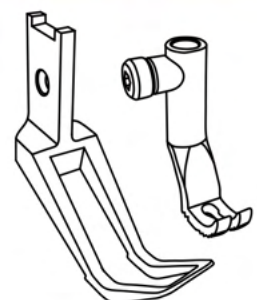

For climbing cross seams

SEWING FEET

RH 1510 PL

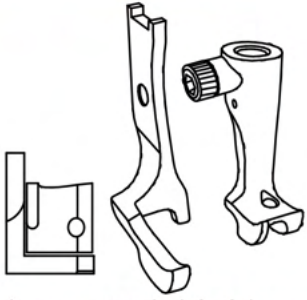

Cording groove on the left of the needle

3, 4, 5, 6 mm

RH 1510 PR

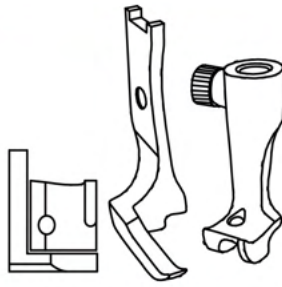

Cording groove on the right of the needle

3, 4, 5, 6 mm

RH 1510 TG

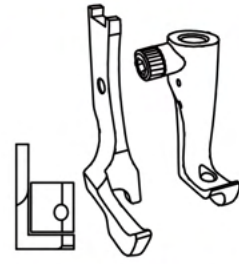

Left cording groove is integrated one half of each in the presser foot and feeding foot

3, 4, 5, 6 mm

GAUGE SETS

0867 - 200010

0867 - 200020

0867 - 200030

0467 - 210070

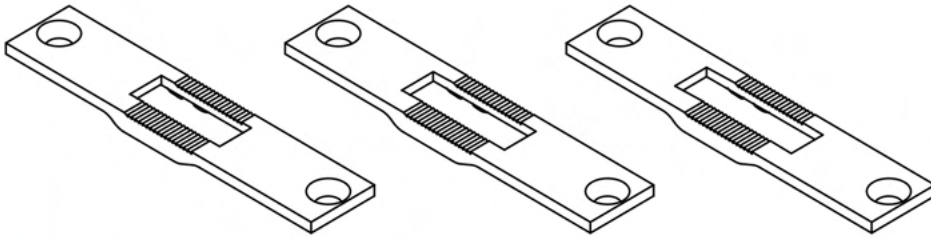

Maximum stitch length 6 mm
6mm

Maximum stitch length 9 mm
9mm

Maximum stitch length 12mm
12mm

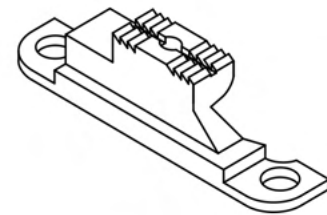

Feed dog 8mm wide
8mm

DOUBLE NEEDLE FEET

RP 767

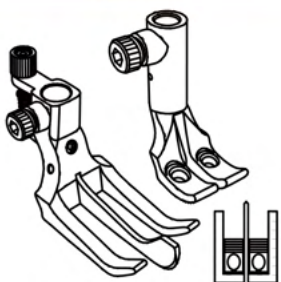

Spring type center guide feet set

5, 6, 8, 10, 12, 14, 16 mm

RP 767 - SO

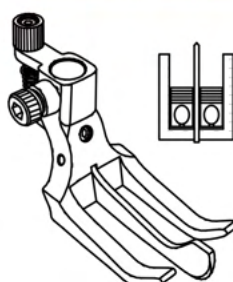

Spring type center guide foot

5, 6, 8, 10, 12, 14, 16 mm

RP 767 - SI

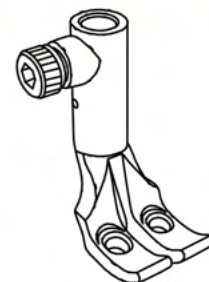

Feeding foot for center guide

5, 6, 8, 10, 12, 14, 16 mm

DOUBLE NEEDLE FEET

RP 768 AO

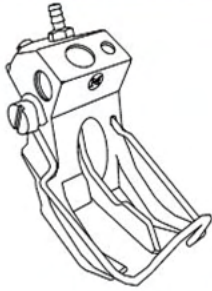

Pneumatic center guide foot

5, 6, 8, 10, 12, 14, 16 mm

RP 768 - I

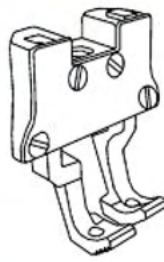

Compensating inner foot

5, 6, 8, 10, 12, 14, 16 mm

RP 768 - IX

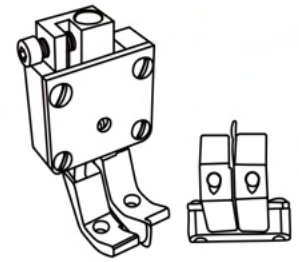

Compensating foot with a center guide on right toe

6, 8, 10, 12, 14 mm

RP 768 - HI

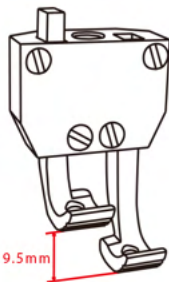

Support larger difference in height

8, 10, 12, 14, 16 mm

RP 767 S

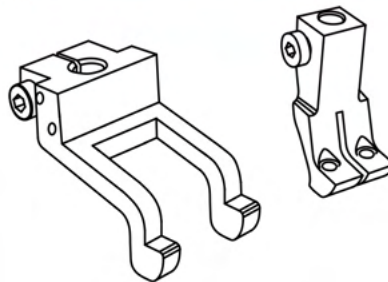

Presser feet for meticulous stitching

6, 8, 10, 12, 14 mm

RP 767 SK

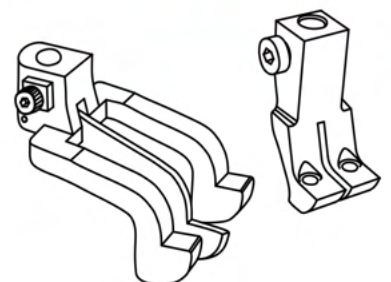

Center guiding feet for meticulous stitching

6, 8, 10, 12 mm

RP 767 UD

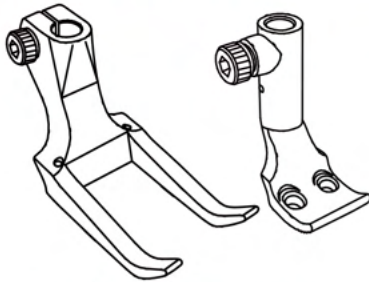

Double needle presser feet set

3, 4, 5, 6, 8, 10, 12, 14, 16 mm

RP 767 U

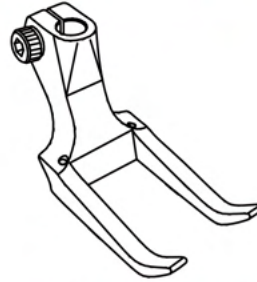

Double needle presser foot

3, 4, 5, 6, 8, 10, 12, 14, 16 mm

RP 767 D

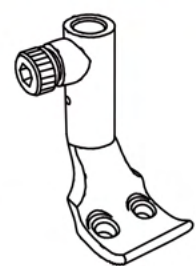

Double needle feeding foot

3, 4, 5, 6, 8, 10, 12, 14, 16 mm

RP 767 EP

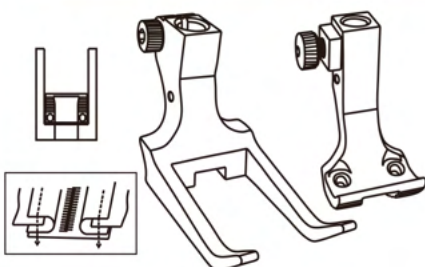

KHF844

Zipper feet

10, 12, 14 mm

RP 768 - MO + KP 768 - MI

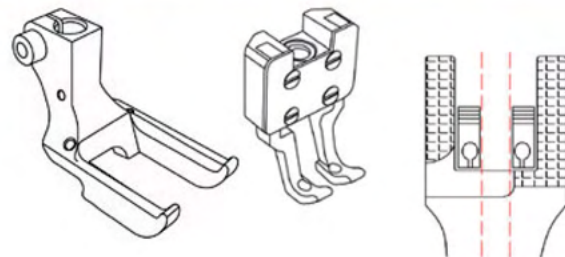

For center cording/piping

8, 10 mm

DOUBLE NEEDLE FEET

GA 767 R

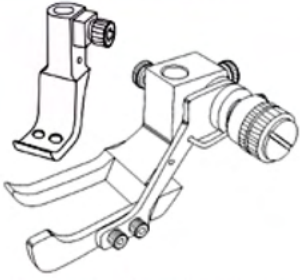

Double needle feet with right guide
Guide pressure and guide level are adjustable

5, 6, 8, 10, 12, 14 mm

RP 768 - ZO

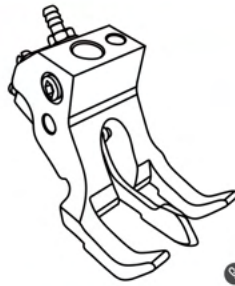

Pneumatic center guiding foot for meticulous stitching

6, 8, 10, 12 mm

RP 768 - ZI

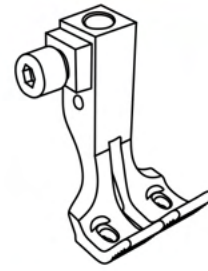

Pneumatic center guide feeding foot for meticulous stitching

6, 8, 10, 12 mm

SEWING FEET

RP 867 UD

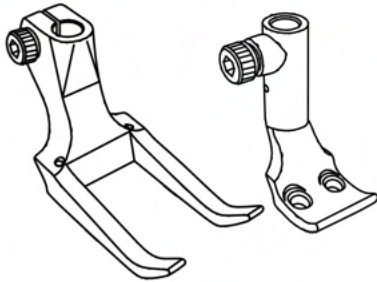

Double needle presser feet set

5, 6, 8, 10, 12, 14, 16 mm

RP 867 U

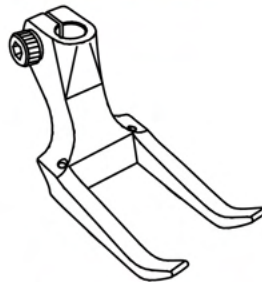

Double needle presser foot

5, 6, 8, 10, 12, 14, 16 mm

RP 767 D



Double needle feeding foot

3, 4, 5, 6, 8, 10, 12, 14, 16 mm

RP 868



Spring type center guide feet set

5, 6, 8, 10, 12, 14, 16 mm

RP 868 - SO

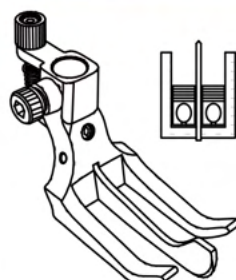

Spring type center guide foot

5, 6, 8, 10, 12, 14, 16 mm

RP 767 - SI



Feeding foot for center guide

5, 6, 8, 10, 12, 14, 16 mm

SEWING FEET

RP 868 AO

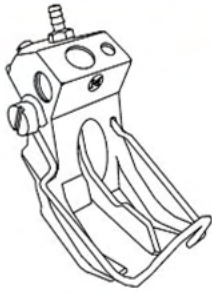

Pneumatic center guide foot

5, 6, 8, 10, 12, 14, 16 mm

RP 768 - I



Compensating inner foot

5, 6, 8, 10, 12, 14, 16 mm

GAUGE SETS

RH 2760 - NP

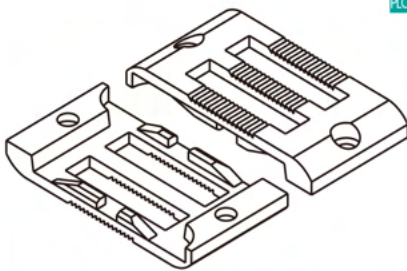

Needle plate for PLC-2760
PLC-2760

5, 6, 8, 10, 12, 14 mm

RH 2760 - NPT

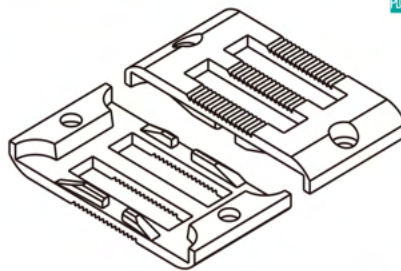

Needle plate with thread trimmer for PLC-2760-7
PLC-2760-7

5, 6, 8, 10, 12, 14 mm

RH 2760 - FD

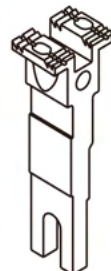

Feed dog

5, 6, 8, 10, 12, 14 mm

RH 2760 - NPC

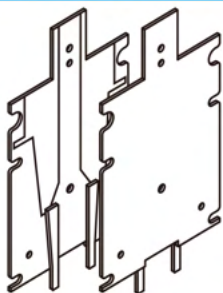

Lateral covers

5, 6, 8, 10, 12, 14 mm

RH 767 - NC

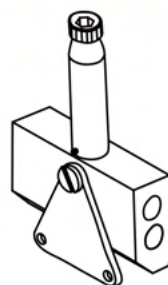

Needle clamp for double needle

3, 4, 5, 6, 8, 10, 12, 14, 16 mm

RH 867 - OSNC

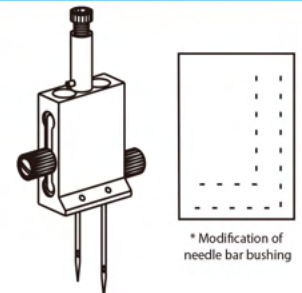

Flip-up needle clamp for double needle

6, 8, 10, 12 mm

* Modification of
needle bar bushing

RA 768

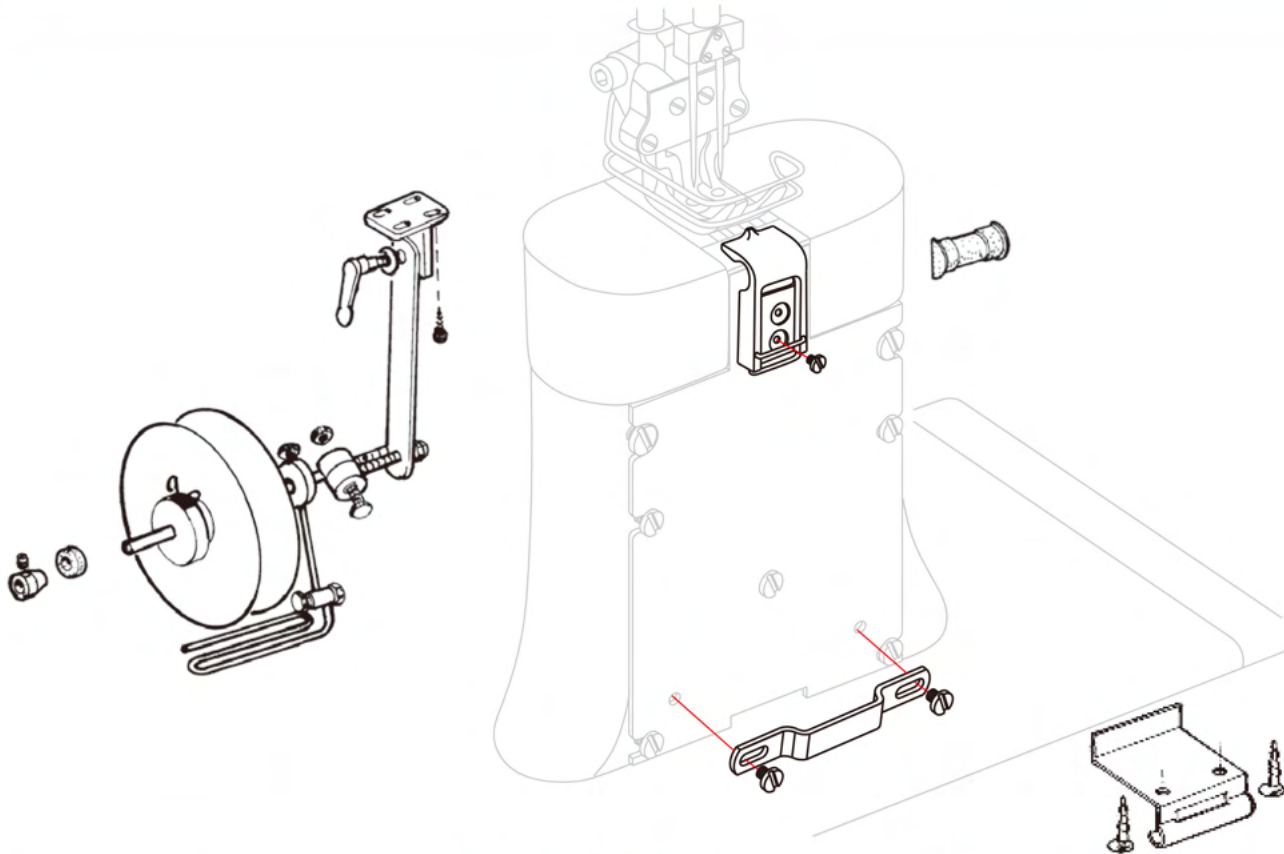

Belt guide completed set for 20mm belt
 * Must be used with KH2760-NP/NPT needle plate & KH2760-NPC lateral covers.

(20mm)
 KH2760-NP/NPT

KH2760-NPC



RA 768 - BG

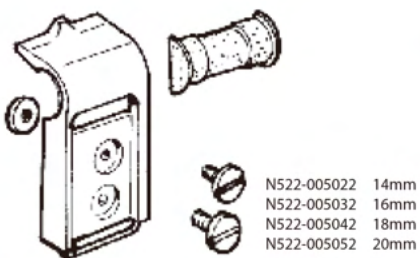

Belt guide completed

10, 12, 14, 16, 18, 20 mm

RA 768 - BI

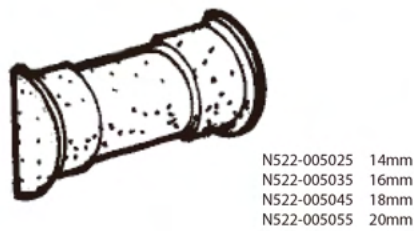

Belt insert

10, 12, 14, 16, 18, 20 mm

N 522 - 005007

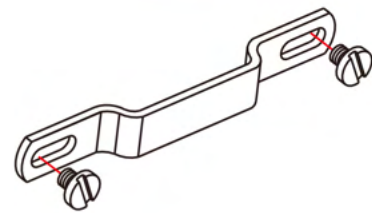

Shackle

N 522 - 005008

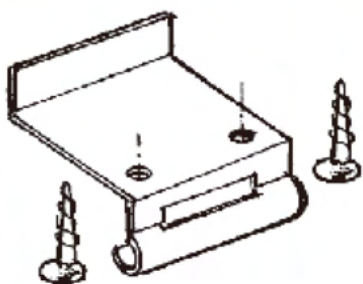

Guiding plate

N 900 - 001527

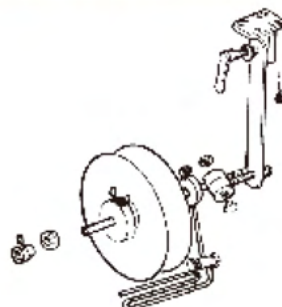

Under table tape roller holder

RG 2760 VP

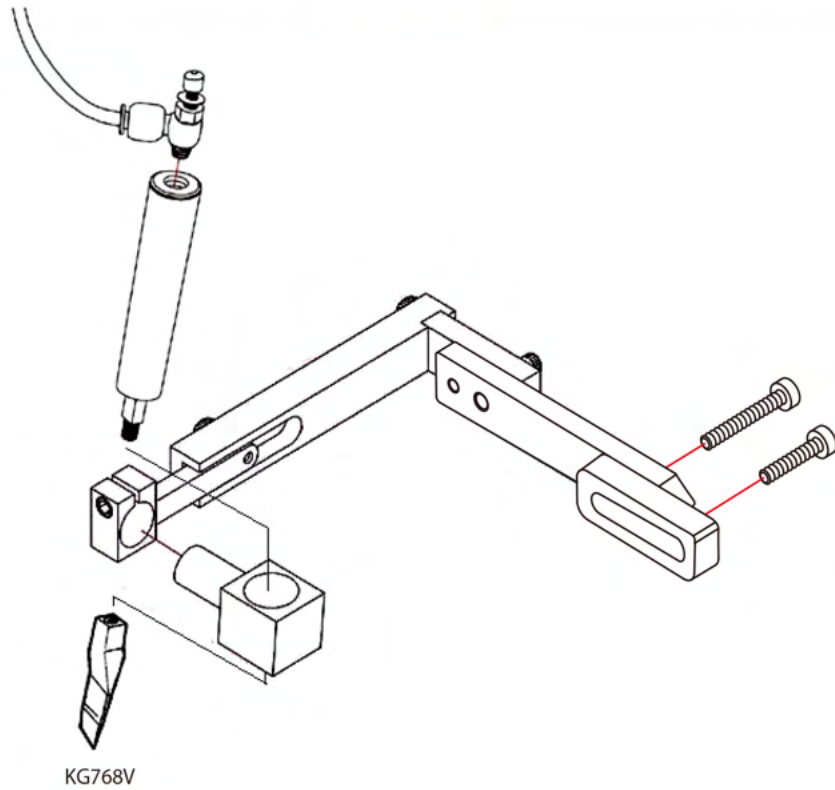

Pneumatic guiding set

RG 768 Y



Piston with holder

RG 768 V



Guiding knife for decorative topstitching

RG 768 M

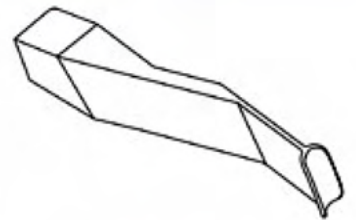

Guiding knife for decorative topstitching with piping

RG 768 C



Guiding knife for decorative topstitching

INDEX

Parts Number	Page	Parts Number	Page	Parts Number	Page	Parts Number	Page
0467-210070	N15	RH1510PR	N15	RHF91045	N07	RP767TP	N04
0667-155100	N05	RH1510TG	N15	RP10711703	N11	RP767TP-I	N04
0867-200010	N15	RH1525-NPB/FDB	N09	RP1245VX	N02	RP767U	N16
0867-200020	N15	RH1525PD	N03	RP141Q	N02	RP767UD	N16
0867-200030	N15	RH1560FG	N05	RP1510F	N14	RP768AO	N16
GA767R	N17	RH205-FNP/FDB	N08	RP1510LN	N14	RP768CC	N03
GD367	N12	RH2760-FD	N18	RP1510-L081	N14	RP768-HI	N16
GL141	N02	RH2760-NP	N18	RP1510-N081	N14	RP768-I	N16, N18
GL1510	N14	RH2760-NPC	N18	RP1510-R081	N14	RP768-IX	N16
GL1510H	N14	RH2760-NPT	N18	RP1510RN	N14	RP768-MO+KP768-MI	N16
GL367	N12	RH2810-NPB+RH467B-FD	N09	RP1510TP	N03, N13	RP768YAO	N01
GL367H	N12	RH291-NB	N04	RP1510TP-I	N03, N13	RP768YC	N01
GL367M	N01, N12	RH367PB	N13	RP1510VX	N14	RP768YCO	N01
GL367X	N12	RH367PC	N13	RP1510W	N14	RP768-YI	N01
GR141	N02	RH367PCS	N13	RP1525B	N09	RP768-ZI	N17
GR1510	N14	RH367PD	N13	RP1525VX	N02	RP768-ZO	N17
GR1510H	N14	RH367PF	N13	RP205B	N09	RP867C	N01
GR367	N12	RH367PJ	N13	RP267TP	N03	RP867CD	N01
GR367H	N12	RH367PL	N13	RP269TP	N04	RP867CD-I	N01
GR367M	N01, N12	RH367PR	N13	RP335FB	N09	RP867COD	N01
GR367X	N12	RH367RFG	N05	RP367B	N09, N11	RP867-N081	N02
RA768	N19	RH367RFG2	N05	RP367F	N11	RP867-N081WR	N02
RA768-BG	N19	RH367TG	N13	RP367LN	N10	RP867UD	N17
RA768-BI	N19	RH467B	N09	RP367LV	N11	RP868	N17
RA768-F	N04	RH669D-NP/FD	N05	RP367N	N10	RP868AO	N18
RA768-FBG	N04	RH669-NP/FD	N05	RP367-L081	N10	RP868-SO	N17
RA768L	N19	RH669-NPB/FDB	N09	RP367-N081	N10	RR-12T	N04
RA768-LBG	N04, N19	RH669R-NP/FD	N05	RP367-R081	N10	RR350	N02
RA768-LBI	N04, N19	RH767AS-SG	N03	RP367RN	N10	N522-005007	N19
RA-CND	N05	RH767-NC	N18	RP367RV	N11	N522-005007L	N19
RA-CNS	N05	RH767TG	N12	RP367S	N11	N522-005008	N19
RB967	N07	RH767WG	N12	RP367T	N10	N900-001527	N19
RB2810	N07	RH768DP	N01	RP367TP	N03, N11	R367R	N12
RG768C	N20	RH768DP-I	N01	RP367TP-I	N03		
RG768M	N20	RH867AS-SG	N03	RP367VC	N10		
RG768V	N20	RH867-BNP/BFD	N09	RP367VX	N10		
RG768Y	N20	RH867FG	N05	RP367W	N10		
RG779L	N06	RH867K-NP/FD	N02	RP367XW	N02, N10		
RG779R	N06	RH867-OSNC	N18	RP367ZP	N11		
RG867P	N06	RH867Q-NP/FD	N02	RP367ZPW	N02, N11		
RG867P-LAK	N06	RHB01	N07	RP467LW	N11		
RG2760VP	N20	RHB669	N07	RP467Q	N10		
RG-AD	N06	RHB767	N07	RP467RW	N11		
RG-BZS	N07	RHF2	N08	RP767	N15		
RH1245-NPB/FDB	N09	RHF3	N08	RP767D	N16, N17		
RH1245PD	N03	RHF4	N08	RP767EP	N16		
RH1296-NB	N04	RHF4410	N08	RP767S	N16		
RH1510FG	N05	RHF867S	N08	RP767-SI	N15, N17		
RH1510PD	N03, N13	RHF867T	N08	RP767SK	N16		
RH1510PL	N15	RHF867UT	N08	RP767-SO	N15		

- Nouveaux produits
- Guide suspendu et support
- Equipement pour bordage
- Pied de biche
- Ecartements
- Pieds double aiguille
- Guide pneumatique

Web: www.acs.tn

